



---

Installation instructions

**Longitudinal bench seat**

**91.1**

**Type 463**

In the above model with wheelbase 2850 mm, the longitudinal bench seat can subsequently be installed on both sides.

The mounting points under the side wall panelling for the seat frame and backrest frame are available as standard.

The side wall panelling must be refinished in accordance with the Installation Instructions.

**MBMANUALS.COM**

## 91.1 Longitudinal bench seat

### A. Installation

- 1 Remove edge protection, door pillar.

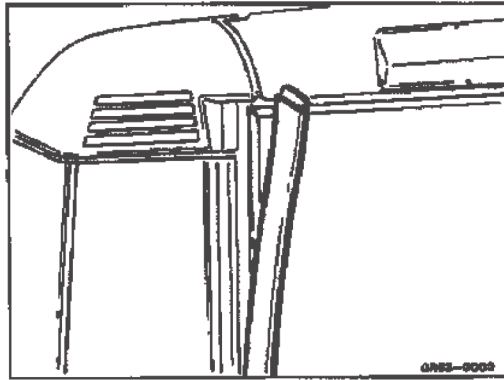

- 2 Remove panelling of rear pillar left and right.

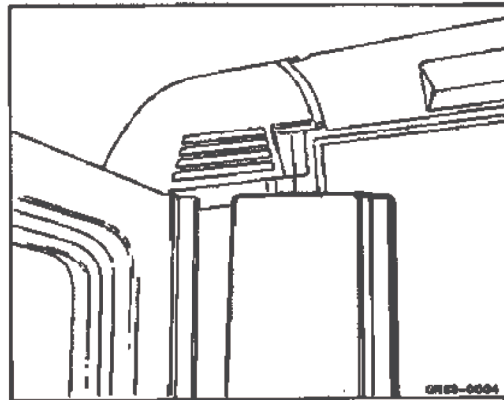

- 3 Remove cap and unscrew seat belt at bottom.

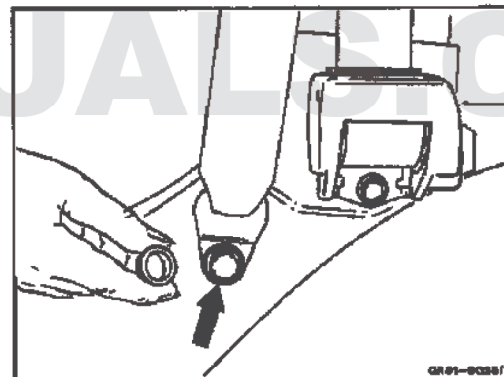

- 4 Remove cap from seat belt at top.

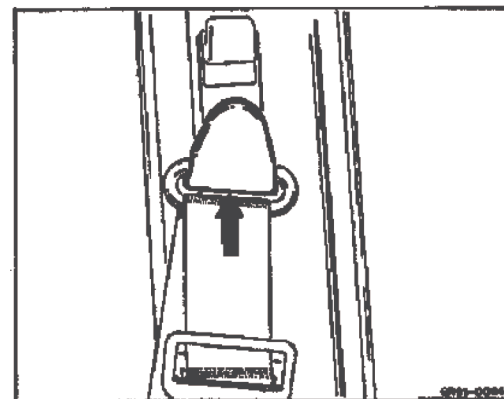

6 Unscrew seat belt.

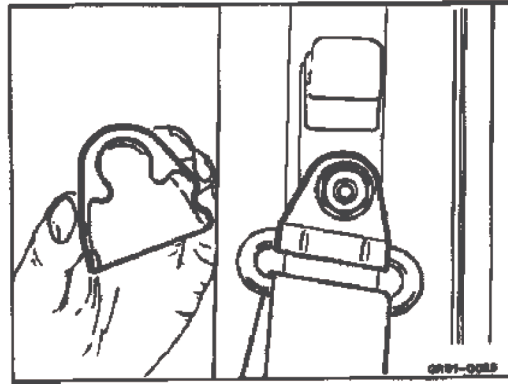

6 Remove side wall panelling from rubber window frame.

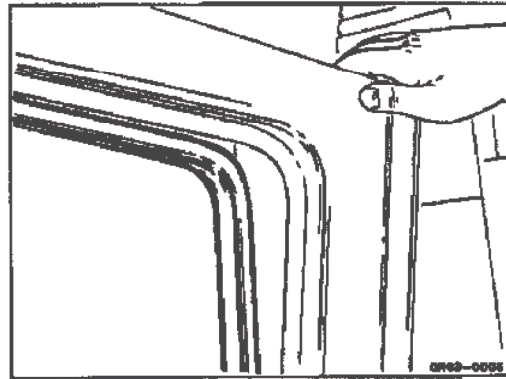

7 Remove rubber seal of rear compartment door.  
Remove side wall panelling.

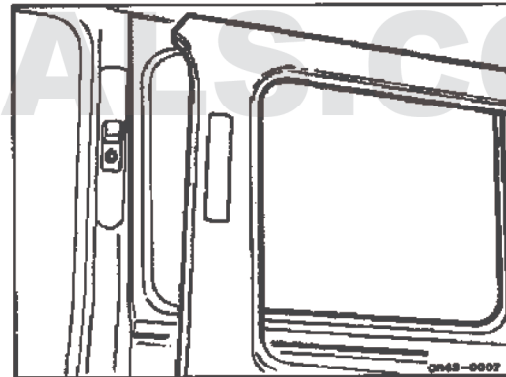

8 Unscrew roof panelling at rear.

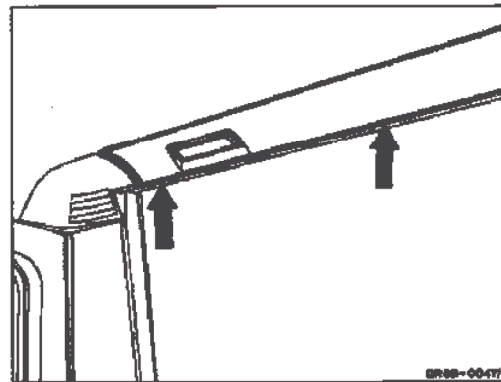

## 91.1 Longitudinal bench seat

9 Unclip dome light.

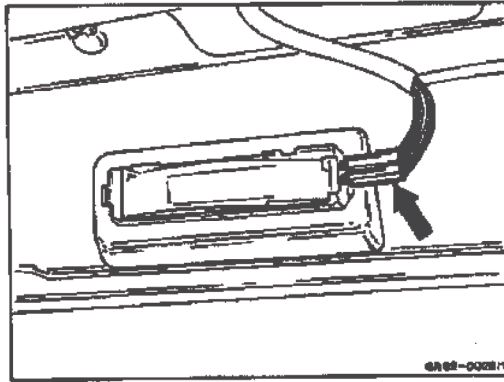

10 Remove ventilation cover.

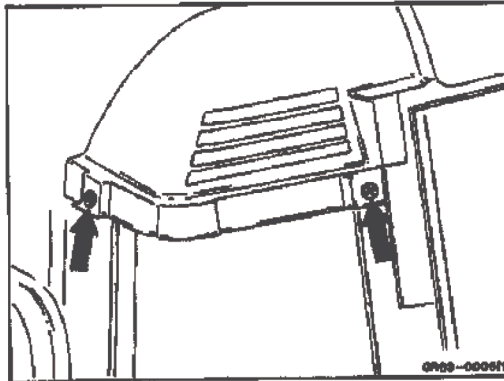

11 Mark fastening bores for the supporting loops on the roof frame. Drill two holes dia. 3,5 mm. (Supporting loops are laterally reversed on the left and right).

12 Treat bores with wax preservation.

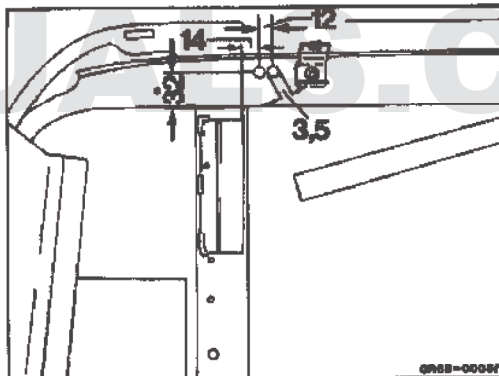

13 Secure supporting loop and holder.

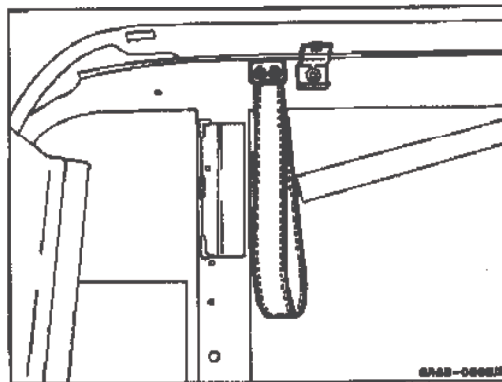

## Longitudinal bench seat 91.1

14 Appropriately leave open roof panelling in the area of the supporting loop.

15 Reduce edge protection of rear door to 932 mm (upper cover of rear door opening).

16 Connect dome light, reassemble panelling and edge protection.

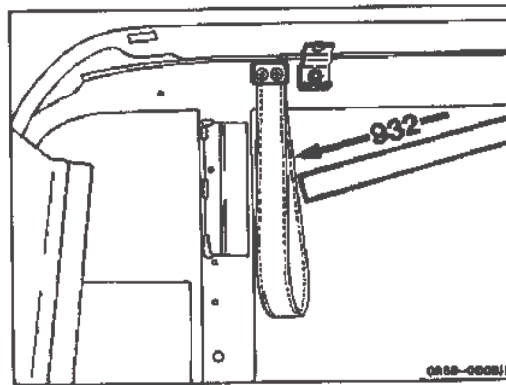

17 Punch 8 holes of dia. 16 mm in side wall panelling according to sketch diagram. Install side wall panelling.

18 Attach seat belt top and bottom.

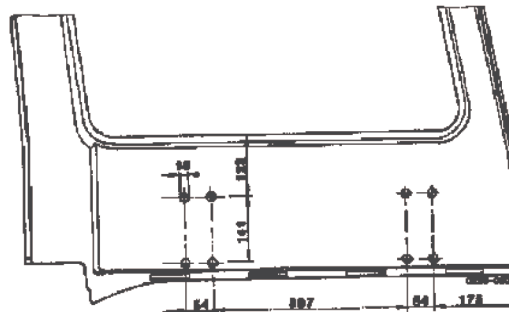

19 Preassemble backrest frame, seat frame and bench seat.

20 Screw backrest frame with seat frame to side wall panelling.

21 Attach backrest cushion.

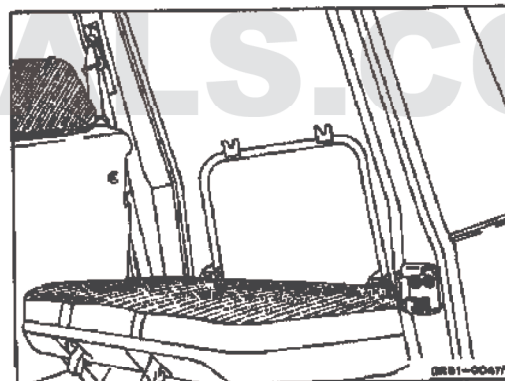

22 Apply step guard left and right. For this purpose degrease the adhesive surfaces on step of bumper.

23 Remove protective foil of step guard and stick on.

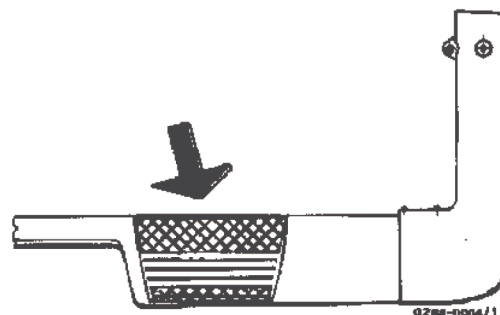



Mercedes-Benz

## INSTALLATION INSTRUCTIONS

Accessory  
**BACK SEAT  
PROTECTOR / COVER**

Application  
**G CLASS MODELS**



### PARTS LIST

- 1) Cover

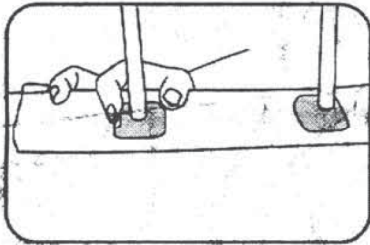

### INSTALLATION INSTRUCTIONS

- 1) Remove all three (3) headrests from the top of the rear seat according to your Owner's manual.



- 2) Place the seat cover over the top of the seat and the seat back section of the seat. Align cut-outs.



- 3) Replace the headrest by aligning the holes in the seat with the "button hole" openings for the headrest support rods sewn into the top seam on the cover.



- 4) Push the foam pillow inserts, attached to the underside of the cover, completely through the seat crevice.

(over)

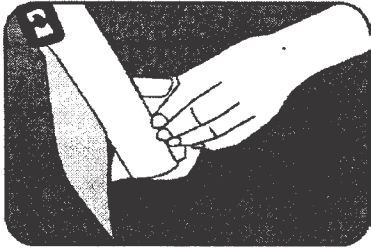

5) Line up the seat belt openings and pull the seat belts through the cover.

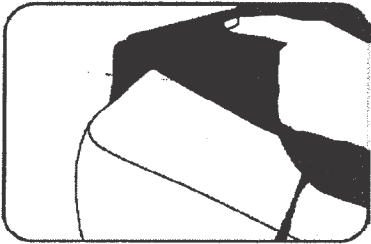

6) Adjust the front and sides of the cover over the bottom section of the seat.

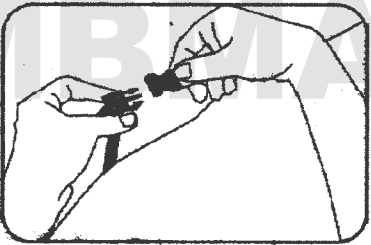

7) Connect the webbing strap buckle assemblies together under the corners of the seat bottom on each side. Make sure the side release buckles are snapped together. Adjust the cover and straps.

#### **CLEANING INSTRUCTIONS**

Cover must be hand washed using cold or warm water.

Use 1/2 cup of liquid FANTASTIK® ALL PURPOSE CLEANER only (not soap or detergents). DO NOT use bleach.

Rinse cover thoroughly - it is most important that all the cleaner be removed. Hang the cover and allow it to drip dry.

**WARNING:** *Do not fold or store a wet cover for more than a couple of days.*